



Cover 4:  
Duchess Pebble

Cover 3:  
Destiny Silver \*

Cover 2:  
Tesseere Pebble

Cover 1:  
Aaron Silver

\* PLEASE NOTE THAT DESTINY FABRIC IS ONLY AVAILABLE AS COVER 3 ON PILLOW BACK AND COVER 2 ON STANDARD BACK.

# Vesper Collection

Colours represented are to be used as a guide only.  
Please refer to manufacturers swatch for a more accurate colour match.

Please note that colour shadings can vary slightly from each roll of fabric.  
We cannot guarantee a precise match to these samples or between cut lengths and upholstered goods.

foamflex™

Award Winning Seating Technology

13/08/2020



# VESPER COVER GUIDE: STANDARD BACK

Please use this guide when ordering the following pieces to clarify cover options.

## STANDARD BACK - Available with & without studs

LH2, COR, RH1 (L2, CO, R1)

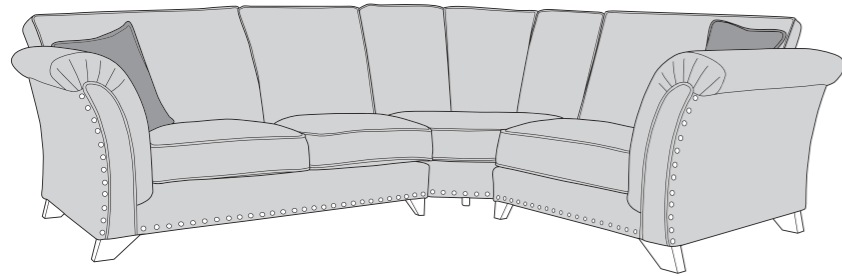

LH1, COR, R2 (L1, CO, R2)

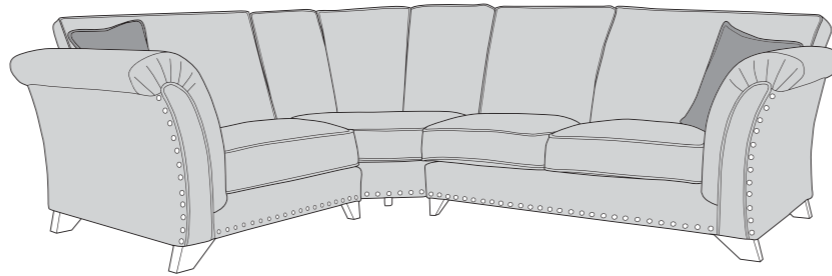

LH1, COR, RH1 (L1, CO, R1)

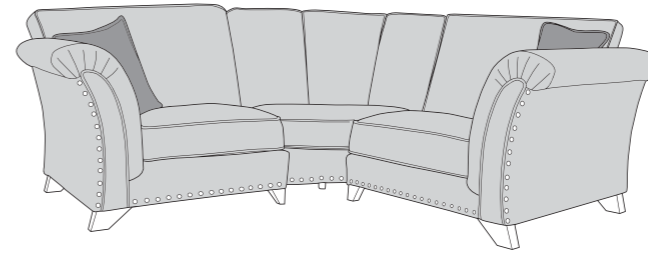

LH2, COR, RH2 (L2, CO, R2)

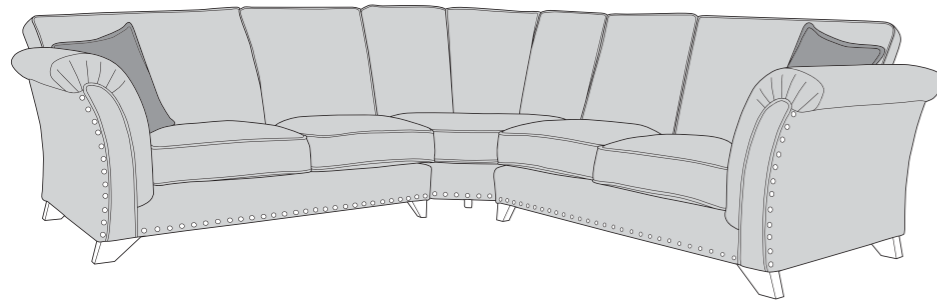

ALU (AU)

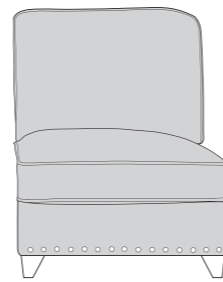

4 Seater Modular Sofa (4MD)

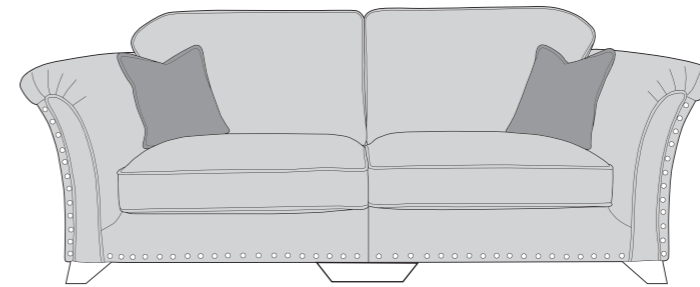

3 Seater Sofa (3ST)

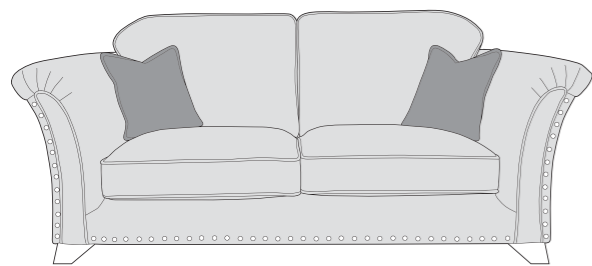

2 Seater Sofa (2ST)

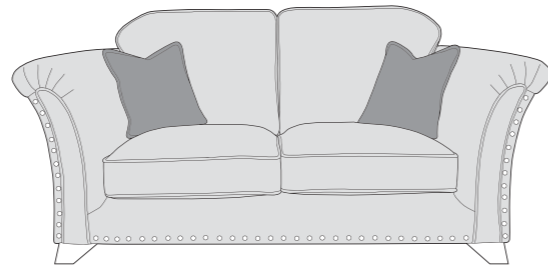

Love Chair (LOV)

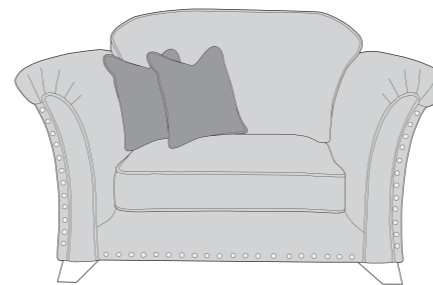

Arm Chair (1ST)

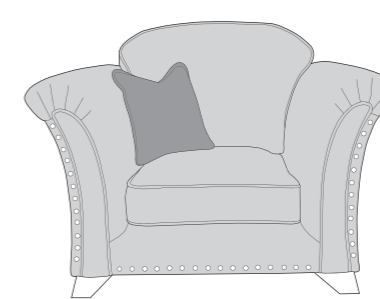

120cm Deluxe Sofa Bed (2DB)

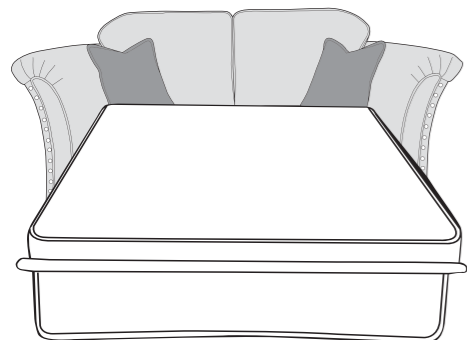

Vesper (Paris) Swivel Chair (SWC)

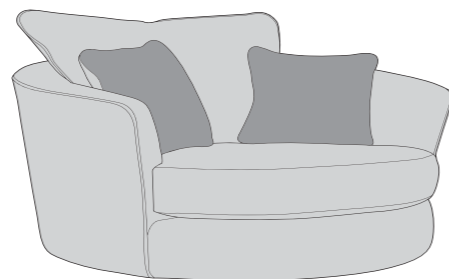

Vesper (Cuddler) Footstool (FST)

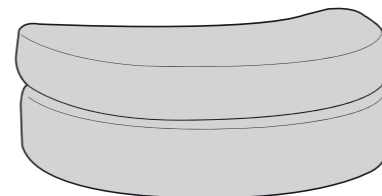

### Standard Back Scatter Cushions

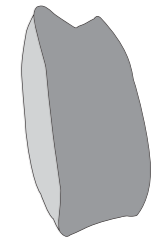

Flanged Edge  
Front = Cover 2  
Back = Cover 1



# VESPER COVER GUIDE: PILLOW BACK

Please use this guide when ordering the following pieces to clarify cover options.

## PILLOW BACK - Available with & without studs

LH2, COR, RH1 (L2, CO, R1)

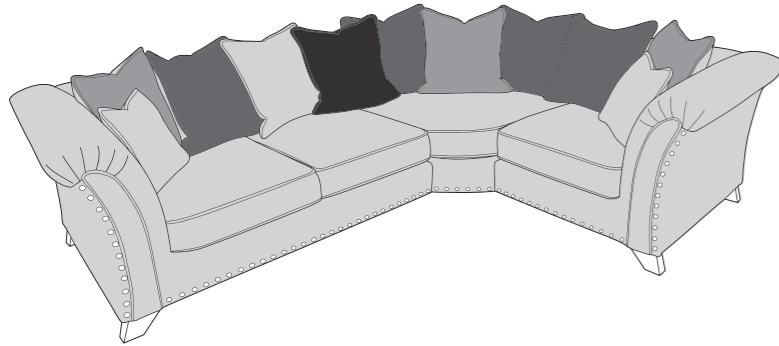

LH1, COR, RH2 (L1, CO, R2)

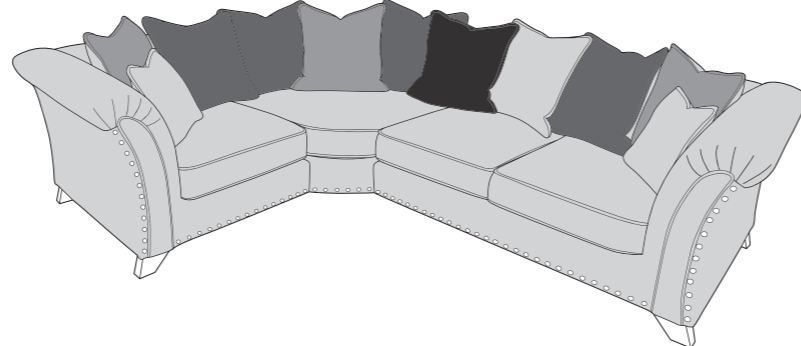

LH1, COR, RH1 (L1, CO, R1)

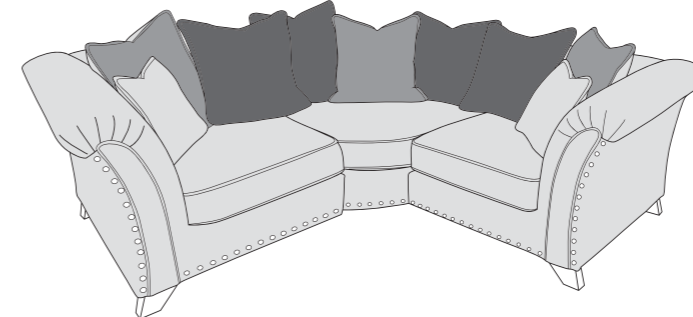

LH2, COR, RH2 (L2, CO, RH2)

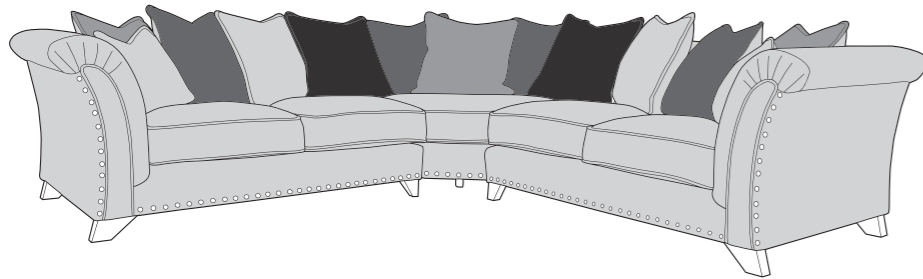

ALU (AU)

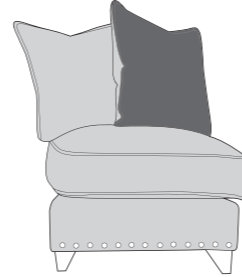

4 Seater Modular Sofa (4MD)

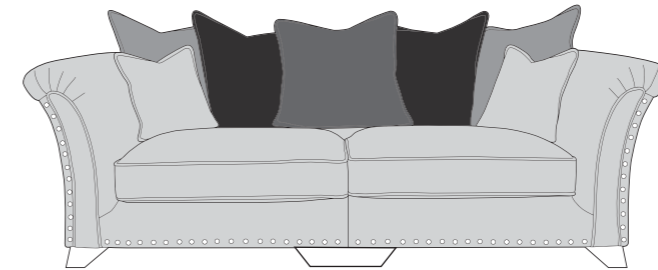

3 Seater Sofa (3ST)

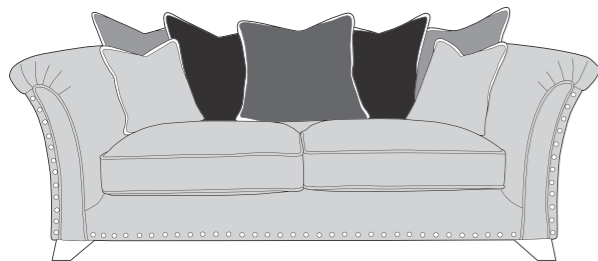

2 Seater Sofa (2ST)

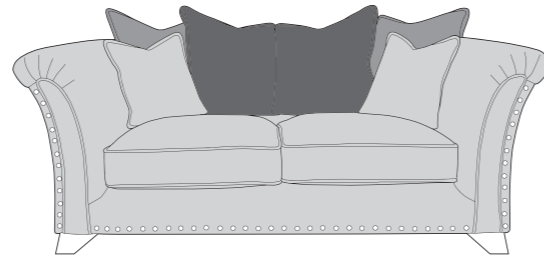

-  **COVER 1**  
(BODY,  
PILLOW,  
SCATTER)
-  **COVER 2**  
(PILLOW)
-  **COVER 3**  
(PILLOW)
-  **COVER 4**  
(PILLOW)

### Pillow Back Cushions

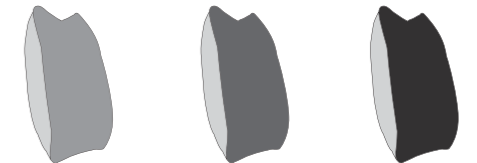

Flanged Edge  
Front = Cover 2  
Back = Cover 1

Flanged Edge  
Front = Cover 3  
Back = Cover 1

Flanged Edge  
Front = Cover 4  
Back = Cover 1

### Pillow Back Scatter Cushions

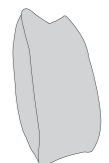

Flanged Edge  
Front = Cover 1  
Back = Cover 1

## ACCENT PIECES

Vesper (Throne)  
Accent Chair (ACH)

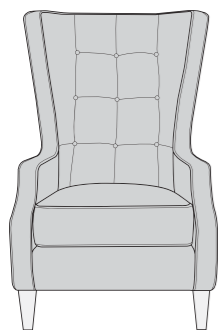

Vesper  
Footstool (FST)

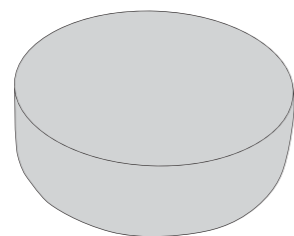

Vesper (Link)  
Footstool (FSS)

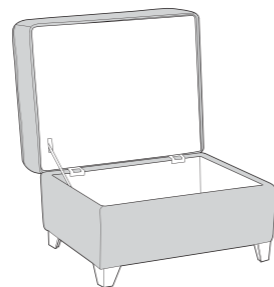

# VESPER DIMENSIONS (CM)

AVAILABLE PIECES	HEIGHT 1	OUTBACK HEIGHT	WIDTH 2	DEPTH 3	ARM HEIGHT	SEAT HEIGHT 4	SEAT DEPTH (STANDARD) 5	SEAT DEPTH (PILLOW) 5	SEAT WIDTH 6	ACCESS DIAGONAL 7	WEIGHT (KG)	SCATTER CUSHION NO.
LH1, COR, RH2 or RH1, COR, LH2 CORNER GROUP	92	79	289	223	81	49	N/A	N/A	N/A	117	135.5	2
LH1, COR, RH1 CORNER GROUP	92	79	223	223	81	49	N/A	N/A	N/A	N/A	126	2
LH2, COR, RH2 CORNER GROUP	92	79	289	289	81	49	N/A	N/A	N/A	402	148	2
LH2/RH2 UNIT	92	79	167	104	81	49	52	52	135	194	52.5	1
LH1/RH1 UNIT	92	79	101	104	81	49	52	52	69	141	40	1
ALU - ARMLESS UNIT	92	79	70	104	N/A	49	52		70	121	24.5	N/A
COR - CORNER UNIT	92	79	122	122	N/A	49	65	65	N/A	173	43	N/A
4ML/4MR UNIT (4MD)	92	79	126	104	81	49	52	52	94	159	46.5	1
<b>SOFA BEDS</b>												
4 SEATER MODULAR SOFA (4MD)	92	79	252	104	81	49	52	52	188	273	93	2
3 SEATER SOFA (3ST)	92	79	219	104	81	49	52	52	155	239	76.5	2
2 SEATER SOFA (2ST)	92	79	200	104	81	49	52	52	136	220	66	2
LOVE CHAIR (LOV)	92	79	158	104	81	49	52	52	91	158	55.5	2
ARM CHAIR (1ST)	92	79	128	104	81	49	52	52	62	160	49.5	1
<b>ACCENT PIECES</b>												
THRONE CHAIR (ACH)	122	N/A	73	88	N/A	52	54	N/A	55	102	28.5	N/A
ROUND FOOTSTOOL (FST)	33	N/A	97	97	N/A	N/A	N/A	N/A	N/A	N/A	22	N/A
STORAGE FOOTSTOOL (FSS)	45	N/A	63	50	N/A	N/A	N/A	N/A	N/A	75	12.5	N/A
<b>SOFA BEDS</b>												
120CM DELUXE SOFA BED (2DB)	96	79	202	104	80	53	65	N/A	136	220	102	2

## SOFABED:

### DELUXE ACTION & SPRUNG MATTRESS

A two fold metal action with beech slats. Complemented by a deluxe sprung mattress. For everyday use.

**Mattress thickness: 11.5cm**

**Mattress Length: 183cm**

**2 fold action is 160Kg total max occupancy weight**



120cm sofa bed:

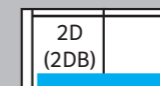

**Mattress Width: 114cm**

Sofa beds available as standard back only

- \* Hardwood & composite board frame.
- \* Dowelled, screwed, glued & stapled joinery.
- \* Light & Antique Wood foot options.

- \* Fibre filled backs for added comfort.
- \* Feather filled scatters included.
- \* Award winning foamflex seat interior with 5 year guarantee.

- \* Serpentine seat springs & silent wire.
- \* Elasticated back webbing.

## DIMENSION GUIDE

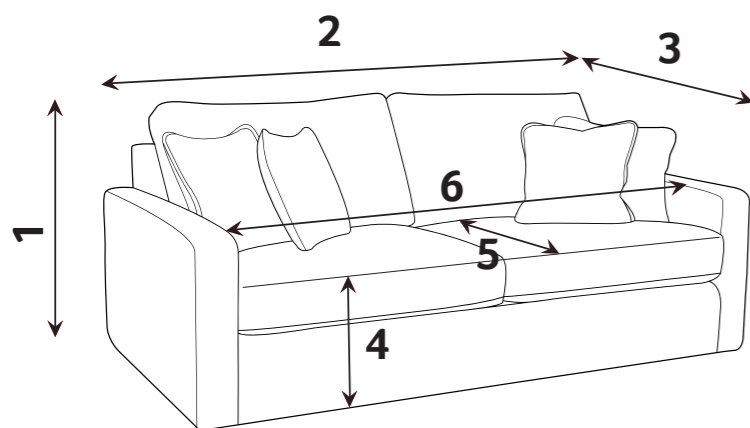

Check the diagonal access dimension to ensure furniture will fit in your home.

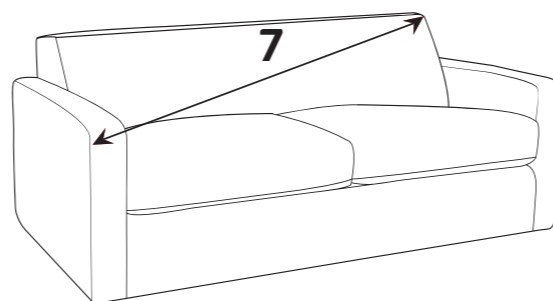

- 1 - HEIGHT
- 2 - WIDTH
- 3 - DEPTH
- 4 - SEAT HEIGHT
- 5 - SEAT DEPTH (STD & PILLOW)
- 6 - SEAT WIDTH
- 7 - DIAGONAL ACCESS

Illustrations used for reference only.

## foamflex™

Our new expertly engineered foam seat interior gives you the comfort of fibre with the retention of foam.

## CARE GUIDE

To improve the longevity of your hand-made furniture, we recommend rotating cushions (where applicable).

For further information on maintaining your furniture, please refer to the Care Guide located under the seat platform.

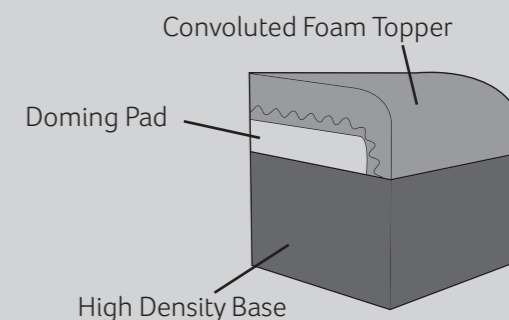

Our foamflex seat interiors have been granted the FIRA GOLD Award, a mark of quality under-pinning all necessary testing of the product materials, design and production techniques.



Beech (Light)

4M Centre Foot

Antique (Dark)

4M Centre Foot

SOFA BED FEET

Antique (Dark)

Beech (Light)

FOOT OPTIONS:



Please note : All dimensions are approximate. Allow tolerance of +/- 2.5cm.

Wood is a natural product and will vary in shade/colour from item to item. Feet may require fitting.

13/08/2020

